

Name: _____ Period: _____

Score:
_____ / _____
_____ %

HW 9-1: Volume

Find the volume of each cylinder. Write your answer in terms of pi and as a decimal rounded to the nearest tenth. Don't forget to label units appropriately.

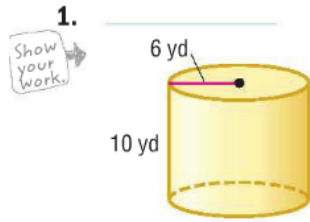

Volume in terms of Pi _____

Approximate Volume _____

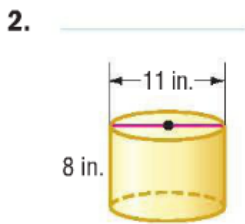

Volume in terms of Pi _____

Approximate Volume _____

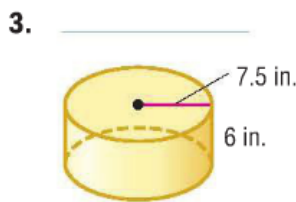

Volume in terms of Pi _____

Approximate Volume _____

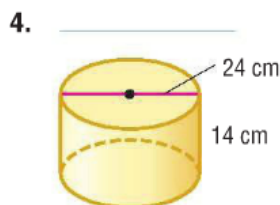

Volume in terms of Pi _____

Approximate Volume _____

Find the volume of each cylinder. Write your answer in terms of pi and as a decimal rounded to the nearest tenth.

5.

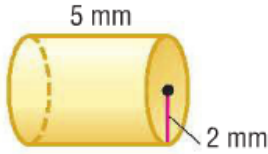

Answer in terms of Pi _____

Approximate Answer _____

6.

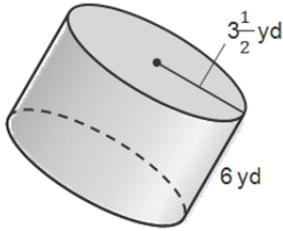

Answer in terms of Pi _____

Approximate Answer _____

Calculate the volume of each cylinder. Write your answer in terms of pi, and as a decimal rounded to the nearest tenth.

7. Radius = 8.8 cm
Height = 4.7 cm

8. Diameter = 10mm
Height = 4 mm

Answer in terms of Pi _____

Approximate Answer _____

Answer in terms of Pi _____

Approximate Answer _____

Calculate the volume of each cone. Write your answer as a decimal rounded to the nearest tenth.

9.

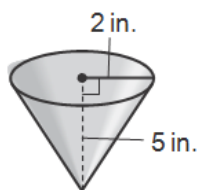

Approximate Answer _____

10.

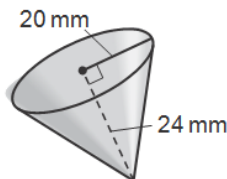

Approximate Answer _____

11.

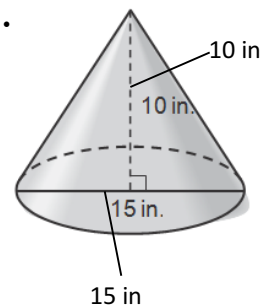

Approximate Answer _____

Calculate the volume of each cone. Write your answer as a decimal rounded to the nearest tenth.

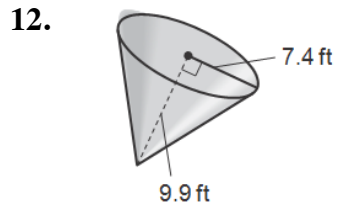

Approximate Answer _____

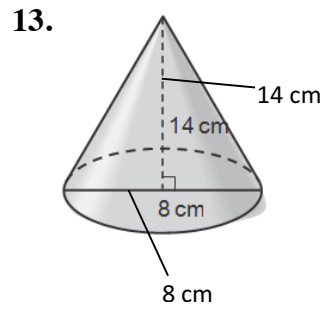

Approximate Answer _____

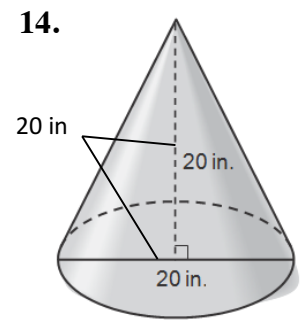

Approximate Answer _____

Calculate the volume of the sphere or hemisphere. Write your answer as a decimal rounded to the nearest tenth.

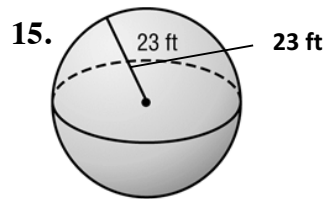

Approximate Answer _____

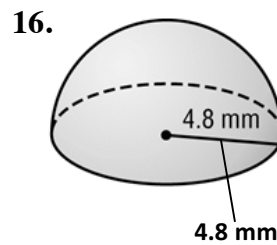

Approximate Answer _____

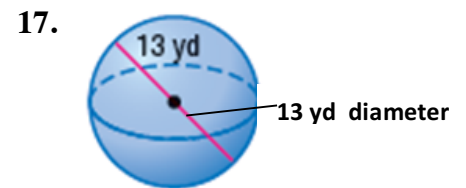

Approximate Answer _____

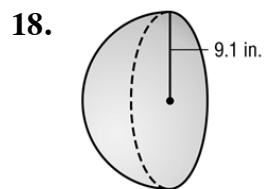

Approximate Answer _____

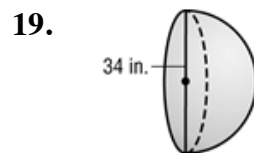

Approximate Answer _____

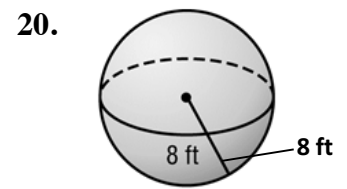

Approximate Answer _____