

HW 6-4

Int 1

Area of Composite Figures

Unit 6

Find the area of each composite figure. Round to the tenths place when necessary. Use the " π " button or 3.14159. Don't forget to label answers with the appropriate measurements.

1)

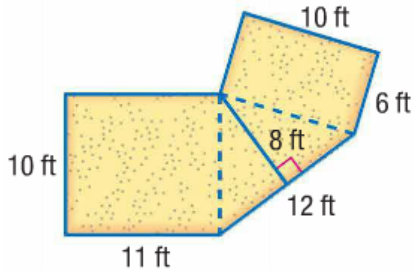

2)

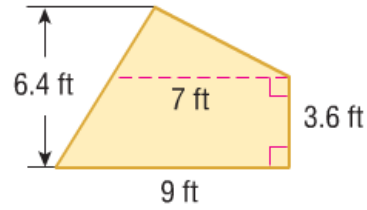

3)

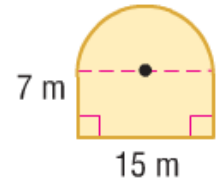

4)

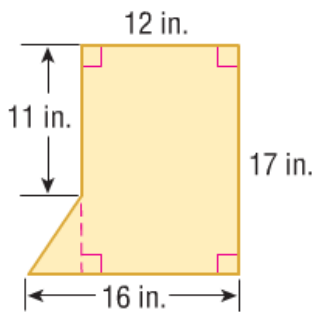

5)

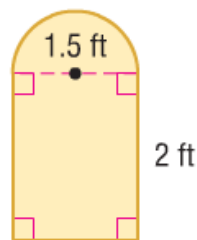

6)

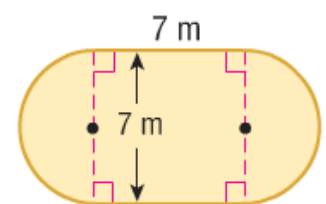

Find the area of each composite figure. Round to the tenths place when necessary. Use the “ π ” button or 3.14159. Don't forget to label answers with the appropriate measurements.

7)

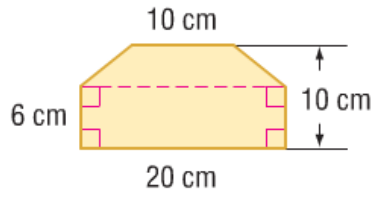

8)

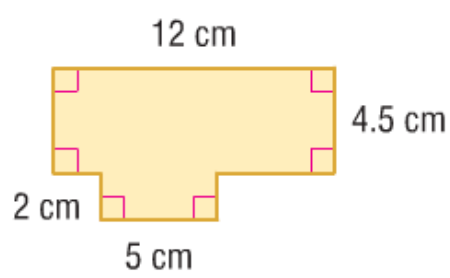

9)

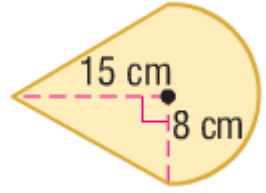

10)

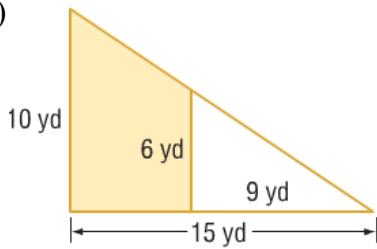

11)

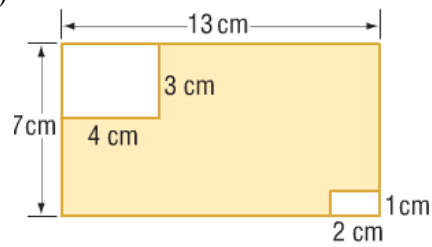

12)

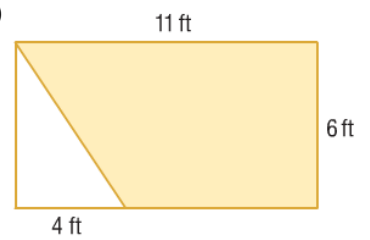

Find the area of each composite figure. Round to the tenths place when necessary. Don't forget to label answers with the appropriate measurements.

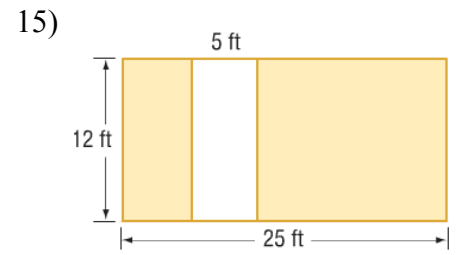
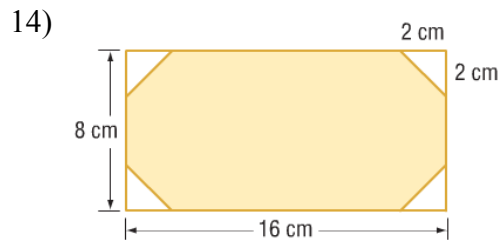
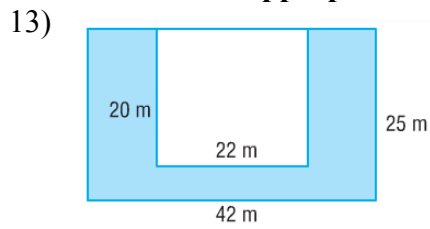

Find the area of figure.

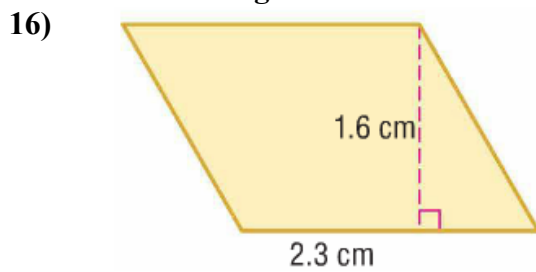

17) What is the area of a triangle with a base of 52 feet and a height of 38 feet?